



MOTOROLA

TALKABOUT® TWO-WAY RADIO

User's Guide



6881041B45-O



Model T6250

ACESSÓRIOS: http://www.acent-radios.com.br/motorola/talk_about/acessorios_talk_about.htm

Introduction

Congratulations on your purchase of a Motorola Product!

Product registration is an important step toward enjoying your new Motorola Product. Registering helps us facilitate warranty service, and permits us to contact you should your Motorola Product require an update or other service. Registration is not required for warranty coverage. To register your product on-line, visit www.motorola.com/warranty/radios.

Please retain your original dated sales receipt for your records. For warranty service of your Motorola Personal Communications Product you will need to provide a copy of your dated sales receipt to confirm warranty status.

Motorola, the Stylized M Logo, and all other trademarks indicated as such herein are trademarks of Motorola, Inc.

® Reg. U.S. Pat. & Tm. Off.

© 2002 Motorola, Inc. All rights reserved. Printed in the U.S.A.

Consumer Products Division
1705 Belle Meade Court
Lawrenceville, GA 30043

For a large-print version of this guide, or for product-related questions, please call 1-800-353-2729 in the USA or 1-888-390-6456 TTY (Text Telephone).

On the web, please refer to the Two-Way Radio section at:
www.motorola.com/store

Contents

Safety and General Information	.4
FCC Licensing Information	...14
Getting Started	...15
Control Buttons and Basic Operation	...15
Installing the Batteries	...16
Battery Meter	...17
Setting the Battery Type	...17
Charging the NiMH Battery (Optional Accessory)	...18
Charging Status	...19
Charging Dock (Optional Accessory)	...20
Turning On Your Radio	...23
Volume	...25
Backlight	...25
Turning Off Your Radio	...25
Setting the Channel	...26
To Set the Channel	...26
Talking and Listening	...27
Special Features	...28
Interference Eliminator Code	...29
Monitor/Signal Strength Indicator	...30

Alerts	...32
Call Tone and Call Display	...32
Ring Only	...33
Ring and/or VibraCall® Alert	...33
Talk Confirmation Tone	...35
Button Beeps	...35
Eavesdrop Reducer	...36
Weather	...39
Setting the Weather Channel	...40
Other Important Features	...42
Lock	...42
Scanning	...42
Scan List Editing	...43
Auto Power Off	...43
Reset	...44
Simple Menu	...44
Accessories	...45
Hands-Free Use (VOX) With Accessories	...45
Hands-Free Use Without Accessories (iVOX)	...45
Frequency and Code Charts	...46
Use and Care	...50
Troubleshooting	...51
Motorola Limited Warranty	...55

Safety and General Information

Important Information on Safe and Efficient Operation

Read This Information Before Using Your Radio

The information provided in this document supersedes the general safety information contained in user guides published prior to July 2000.

Transmit and Receive Procedure

Your two-way radio contains a transmitter and a receiver. To transmit (talk), you must push the Push-to-Talk button; to receive (listen), release the Push-to-Talk button.

Exposure to Radio Frequency Energy

Your Motorola radio is designed to comply with the following national and international standards and guidelines regarding exposure of human beings to radio frequency electromagnetic energy:

- United States Federal Communications Commission, Code of Federal Regulations; 47 CFR part 2 sub-part J
- American National Standards Institute (ANSI) / Institute of Electrical and Electronic Engineers (IEEE) C95. 1-1992
- Institute of Electrical and Electronic Engineers (IEEE) C95.1-1999 Edition
- International Commission on Non-Ionizing Radiation Protection (ICNIRP) 1998

ACESSÓRIOS: http://www.acent-radios.com.br/motorola/talk_about/acessorios_talk_about.htm

- Ministry of Health (Canada) Safety Code 6. Limits of Human Exposure to Radio Frequency Electromagnetic Fields in the Frequency Range from 3 kHz to 300 GHz, 1999
- Australian Communications Authority Radiocommunications (Electromagnetic Radiation - Human Exposure) Standard 2001 (applicable to wireless phones only)

To assure optimal radio performance and make sure human exposure to radio frequency electromagnetic energy is within the guidelines set forth in the above standards, always adhere to the following procedures:

Portable Radio Operation and EME Exposure

Antenna Care

Use only the supplied or an approved replacement antenna. Unauthorized antennas, modifications, or attachments could damage the radio and may violate FCC regulations.

DO NOT hold the antenna when the radio is “IN USE.” Holding the antenna affects the effective range.



Two-Way Radio Operation

When using your radio as a traditional two-way radio, **hold the radio in a vertical position with the microphone one to two inches (2.5 to 5 cm) away from the lips.**

ACESSÓRIOS: http://www.acent-radios.com.br/motorola/talk_about/acessorios_talk_about.htm

To control your exposure and ensure compliance with the general population/uncontrolled environment exposure limits, always adhere to the following procedure:

- Transmit no more than 50% of the time.
- To transmit (talk), push the Push-to-Talk (PTT) button.
- To receive calls, release the PTT button.

Transmitting 50% of the time, or less, is important because the radio generates measurable RF energy exposure only when transmitting (in terms of measuring standards compliance).

Body-Worn Operation

To maintain compliance with FCC/Health Canada RF exposure guidelines, if you wear a radio on your body when transmitting, always place the radio in a Motorola-supplied or approved clip, holder, holster, case, or body harness for this product. Use of non-Motorola-approved accessories may exceed FCC/Health Canada RF exposure guidelines. If you do not use one of the Motorola-supplied or approved body-worn accessories, and are not using the radio held in the normal use position, **ensure the radio and its antenna are at least one inch (2.5 cm) from your body when transmitting.**

Data Operation

If applicable, when using any data feature of the radio with or without an accessory cable, **position the radio and its antenna at least one inch (2.5 cm) from the body.**

Approved Accessories

For a list of approved Motorola accessories visit our website at **www.mot.com**.

Electromagnetic Interference/Compatibility

Note: Nearly every electronic device is susceptible to electromagnetic interference (EMI) if inadequately shielded, designed or otherwise configured for electromagnetic compatibility.

Facilities

To avoid electromagnetic interference and/or compatibility conflicts, turn off your radio in any facility where posted notices instruct you to do so. Hospitals or health care facilities may be using equipment that is sensitive to external RF energy.

Aircraft

When instructed to do so, turn off your radio when on board an aircraft. Any use of a radio must be in accordance with applicable regulations per airline crew instructions.

Medical Devices

Pacemakers

The Advanced Medical Technology Association recommends that a minimum separation of 6 inches (15 centimeters) be maintained between a handheld wireless radio and a pacemaker. These recommendations are consistent with the independent research by, and recommendations of the U.S. Food and Drug Administration.

ACESSÓRIOS: http://www.acent-radios.com.br/motorola/talk_about/acessorios_talk_about.htm

Persons with pacemakers should:

- ALWAYS keep the radio more than six inches (15 centimeters) from their pacemaker when the radio is turned ON.
- not carry the radio in the breast pocket.
- use the ear opposite the pacemaker to minimize the potential for interference.
- turn the radio OFF immediately if you have any reason to suspect that interference is taking place.

Hearing Aids

Some digital wireless radios may interfere with some hearing aids. In the event of such interference, you may want to consult your hearing aid manufacturer to discuss alternatives.

Other Medical Devices

If you use any other personal medical device, consult the manufacturer of your device to determine if it is adequately shielded from RF energy. Your physician may be able to assist you in obtaining this information.

Safety and General Use While Driving

Check the laws and regulations on the use of radios in the area where you drive. Always obey them.

When using your radio while driving, please:

- Give full attention to driving and to the road.
- Use hands-free operation, if available.
- Pull off the road and park before making or answering a call if driving conditions so require.

Operational Warnings

For Vehicles with an Air Bag

Do not place a portable radio in the area over an air bag or in the air bag deployment area. Air bags inflate with great force. If a portable radio is placed in the air bag deployment area and the air bag inflates, the radio may be propelled with great force and cause serious injury to occupants of the vehicle.

Potentially Explosive Atmospheres

Turn off your radio prior to entering any area with a potentially explosive atmosphere, unless it is a radio type especially qualified for use in such areas as “Intrinsically Safe.” Do not remove, install, or charge batteries in such areas. Sparks in a potentially explosive atmosphere can cause an explosion or fire resulting in bodily injury or even death.

Note: The areas with potentially explosive atmospheres referred to above include fueling areas such as below decks on boats, fuel or chemical transfer or storage facilities, areas where the air contains chemicals or particles, such as grain, dust or metal powders, and any other area where you would normally be advised to turn off your vehicle engine. Areas with potentially explosive atmospheres are often but not always posted.

ACESSÓRIOS: http://www.acent-radios.com.br/motorola/talk_about/acessorios_talk_about.htm

Blasting Caps and Areas

To avoid possible interference with blasting operations, turn off your radio when you are near electrical blasting caps, in a blasting area, or in areas posted: “Turn off two-way radio.” Obey all signs and instructions.

Operational Cautions

Antennas

Do not use any portable radio that has a damaged antenna. If a damaged antenna comes into contact with your skin, a minor burn can result.

Batteries

All batteries can cause property damage and/or bodily injury such as burns if a conductive material such as jewelry, keys, or beaded chains touch exposed terminals. The conductive material may complete an electrical circuit (short circuit) and become quite hot. Exercise care in handling any charged battery, particularly when placing it inside a pocket, purse, or other container with metal objects.

Charger Safety Instructions

Before using the battery charger, read all instructions and cautionary markings on the:

1. battery
2. battery charger, and
3. radio using the battery.

Caution: To reduce the risk of injury, charge only the rechargeable batteries listed below. Other types of batteries may burst, causing personal injury and damage.

Single-Unit Charger

Kit Number	Description
NTN9393	110V - NiMH Charging Adapter

Batteries

Kit Number	Capacity in milliampere-hour mAH	Composition
NTN9395	550 mAH	NiMH

Save these Instructions

1. Do not expose the charger to rain or snow.
2. Do not operate the charger if it has received a sharp blow, or has been dropped or damaged in any way.
3. Do not disassemble the charger if it has received a sharp blow, or has been dropped or damaged in any way.
4. Never alter the AC cord or plug provided with the unit. If plug will not fit the outlet, have proper outlet installed by a qualified electrician. An improper condition can result in a risk of electric shock.
5. To reduce risk of damage to cord or plug, pull the plug rather than the cord when disconnecting charger from AC receptacle.
6. To reduce the risk of electric shock, unplug the charger from the outlet before attempting any maintenance or cleaning.
7. Use of an attachment not recommended or sold by Motorola may result in a risk of fire, electric shock, or personal injury.
8. Make sure that the cord is located so that it will not be stepped on, tripped over, or subjected to damage or stress.

ACESSÓRIOS: http://www.acent-radios.com.br/motorola/talk_about/acessorios_talk_about.htm

9. An extension cord should not be used unless absolutely necessary. Use of an improper extension cord could result in a risk of fire and/or electric shock. If an extension cord must be used, make sure:
 - That the pins on the plug of the extension cord are the same number, size and shape as those on the plug of the charger.
 - That the extension cord is properly wired and in good electrical condition, and
 - That the cord size is 18 AWG for lengths up to 100 feet, and 16 AWG for lengths up to 150 feet.
10. The supply cord of this charger cannot be replaced. If the cord is damaged, call Motorola Customer Care Center at 1-800-353-2729 in the USA or 1-888-390-6456 TTY (Text Telephone).

FCC Licensing Information

Your Motorola radio operates on General Mobile Radio Service (GMRS) frequencies and is subject to the Rules and Regulations of the Federal Communications Commission (FCC). The FCC requires that all operators using General Mobile Radio Service (GMRS) frequencies obtain a radio license before operating their equipment. To obtain the FCC licensing forms, please request Forms **605** and **159**. If you want to have the document faxed, mailed, or have questions, please use the following contact information.

Faxed
Contact the Fax-On-Demand system at:

1-202-418-0177

Mailed
Call the FCC forms hotline at:

1-800-418-FORM
1-800-418-3676

Questions
regarding FCC license
Contact the FCC at:

1-888-CALL-FCC
1-888-225-5322
Or: <http://www.fcc.gov>

Changes or modifications not expressly approved by Motorola may void the user's authority granted by the FCC to operate this radio and should not be made. To comply with FCC requirements, transmitter adjustments should be made only by or under the supervision of a person certified as technically qualified to perform transmitter maintenance and repairs in the private land mobile and fixed services as certified by an organization representative of the user of those services. Replacement of any transmitter component (crystal, semiconductor, etc.) not authorized by the FCC equipment authorization for this radio could violate FCC rules. **Note:** Use of this radio outside the country where it was intended to be distributed is subject to government regulations and may be prohibited.

Getting Started

Control Buttons and Basic Operation

Use  (Power) **to:**
- Turn power on/off



Use  **to:**
- Scroll through menus
- Lock the keypad (when held down and not in a menu)
- Exit the menu (when held down while in a menu)

Use  (Call) **to:**
- Transmit call tone

Use  **to:**
- Talk on the radio
- Exit the menu (when briefly pressed while in a menu)

Indicator Light

Use  **to:**
- Turn on backlight (short press).
- Press and hold to switch between weather mode and two-way mode.

Use  and  **to:**
- Adjust volume
- Scroll through menu settings

Use  (Scan/Monitor) **to:**
- Turn scan on/off (short press)
- Monitor the channel & check signal strength (long press)

Microphone

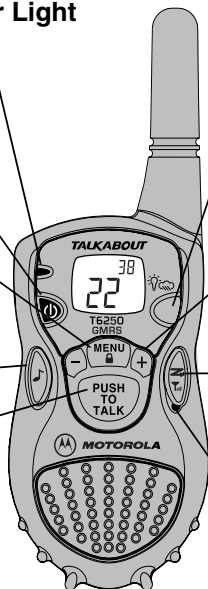



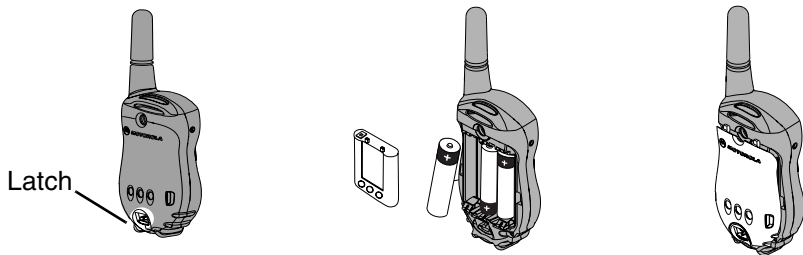

Installing the Batteries

Your radio uses 3 AA Alkaline batteries or a rechargeable Nickel-Metal Hydride (NiMH) battery (sold separately). A NiMH battery upgrade kit (56319) is also available. Call 1-800-353-2729 in the USA for a dealer nearest you.

1. If the radio is on, turn it off by pressing and holding .
2. Push latch up until it clicks.
3. Lift back cover off
4. Remove and replace batteries so the + marking matches the one in the compartment or the NiMH charge contacts are facing out toward the battery door.
5. Hook back cover on the hinges.
6. Close the battery door, pressing lightly until the latch clicks and returns to its original position.









Battery Meter

The battery meter on the top-left corner of the display shows how much battery power you have. It shows  (full),  (two-thirds full),  (one-third full), or  (empty). When the battery is low () , the radio beeps every 10 minutes indicating it's time to change or charge them.

Setting the Battery Type

This feature is used to set the battery meter to recognize and properly display the power usage for either alkaline or rechargeable batteries.

To set the battery type, press  until  is displayed. Press  or  until your choice of  (alkaline) or  (NiMH or NiCad) is displayed, then press  to set.

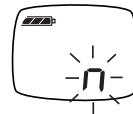

Charging the NiMH Battery (Optional Accessory)

Charge the NiMH battery overnight (16 hours) before using it for the first time. It will only need up to four hours of charging thereafter.

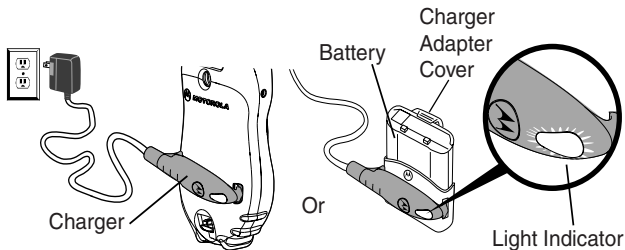

1. If the radio is on, turn it off by pressing and holding , or place the NiMH battery in the charger adapter cover.
2. At the contacts on the back of the radio (or if you are charging just the battery, at the battery contacts), position the charger so the large hook on the end of the charger is over the large slot on the battery door, or if you are charging the battery by itself, on the large slot on the charger adapter cover.
3. Place the small hook on the other end of the charger over the small slot and snap it into place.
4. Plug in the charger.

Charging Status

The light indicator shows the charging status when the charger is connected to the radio, the NiMH battery, or the charging dock.

Light Indicator Color	Charging Status and Description	Charging Level Complete
Solid Red	Rapid charging	Up to 90%
Flashing Green	Top-off charging	90% to 100%
Solid Green	Charging complete	100%
Flashing Red	Battery is faulty. If flashing red continues for more than one minute, the battery is faulty and should be replaced.	-
Flashing Yellow	Standby - Battery waiting to charge. Temperature out of range for charging; must be between 5° to 40° C or 41° to 104° F	-

Note: When moving between hot and cold environments, do not charge the battery until the battery temperature acclimates (usually about 20 minutes). When charging the battery by itself, remove the charger from the charger adapter cover before inserting and/or removing the battery from the charger adapter cover.

ACESSÓRIOS: http://www.acent-radios.com.br/motorola/talk_about/acessorios_talk_about.htm

Charging Dock (Optional Accessory)

The charging dock provides drop-in charging convenience. The charging dock can be mounted or placed on any flat surface (such as a wall or workbench) and turns your radio into a stationary intercom while keeping it charged and ready for any adventure. To mount the charging dock:

1. Wrap the power cord under the charging dock. Use the cutouts to hold the cord in place.
2. Attach using two #6 x $\frac{3}{4}$ " screws for the mounting surface.

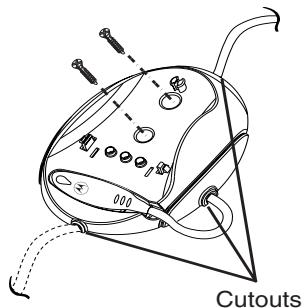

ACESSÓRIOS: http://www.acent-radios.com.br/motorola/talk_about/acessorios_talk_about.htm

3. Position the charger with the hook on the light indicator end over the left slot.
4. Snap the hook on the cord end into the right slot, clamping the charger onto the charging dock contacts.
5. Plug in the charger.
6. Place the radio, or the NiMH battery in the charger adapter cover, into the charging dock until you hear a click.
7. When the light indicator turns solid green, the battery is fully charged.

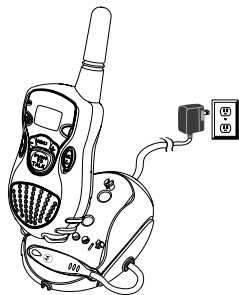
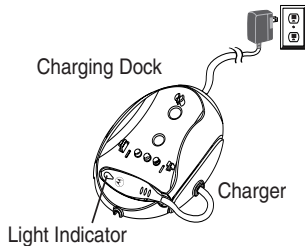

Belt Clip

- Squeeze the top and bottom of the clip to attach or detach the clip from the radio.

Note: The belt clip holds the radio while being worn on your belt. It was designed for your convenience and is not meant to secure your radio under all circumstances. For high activity environments, an accessory carry case is more appropriate to secure the radio.

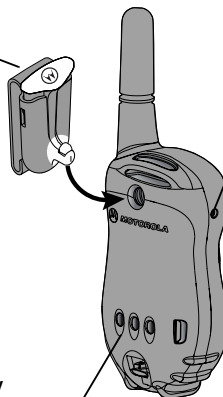



When using audio accessories, ensure that they are plugged in before you turn on the radio *

* Motorola recommends that the volume level is kept at a comfortable listening level when using audio accessories.



NiMH Battery Charging Contacts

Turning On Your Radio

Normal Menu Mode

Press and hold . The radio beeps and the screen temporarily displays every image. The red light above the  button flashes every three seconds.

Simple Menu Mode

Press and hold  and . The radio beeps and the screen temporarily displays only six images.

The red light above the  button flashes every three seconds. You have access to only the Channel, Code, and Call Tone menus.

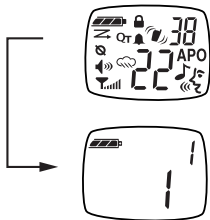

Normal Menu Mode

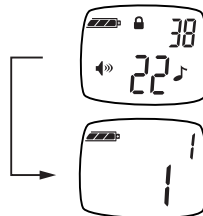

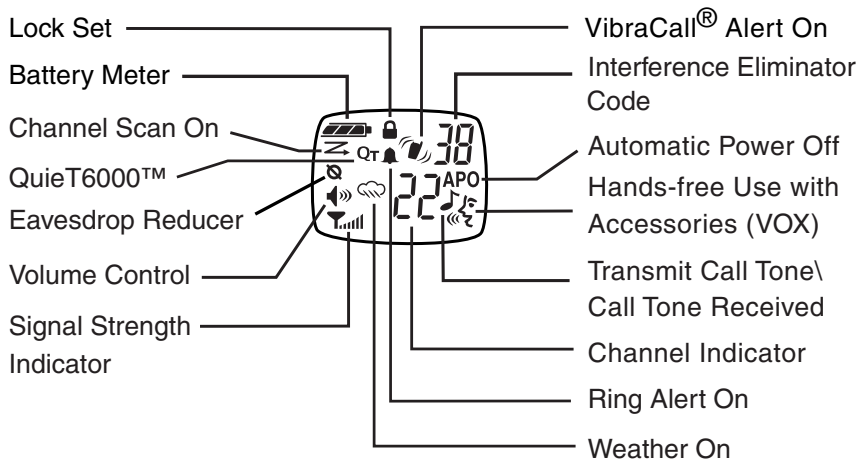

Simple Menu Mode

Your Radio's Display





Volume

You can set the volume whenever you are not using a menu. Press  or  until it's just right. The display shows  and the current volume setting (1 to 20) with 1 being the lowest volume and 20 being the highest volume.



Backlight

Your radio has a backlight that turns on automatically any time you press a button. The backlight turns off automatically four seconds after you last pressed a button. You can also illuminate your display by pressing  .

Turning Off Your Radio

To turn off your radio press and hold  for one second. The radio beeps and the display goes blank.

Setting the Channel

To Set the Channel



The channel is the radio frequency wave your radio uses to transmit. Refer to the Frequency and Code Charts beginning on page 46 for channel and code choices.





1. Press **MENU** once. The channel number begins to blink.
2. Press **-** or **+** to set the channel.
3. Go to the next menu or wait 10 seconds to save the channel setting. To quickly exit the menu and go back to the first display screen, press **PUSH TO TALK**.

The red indicator light above the **⏏** button flashes quickly whenever the channel is in use. Keep scrolling until you find a clear channel.

Talking and Listening

Press and hold  and talk two-to-three inches away from the microphone. When you're finished, just release  (press and hold to talk, release to listen). While transmitting, the red indicator light above the  button glows.

Note: The microphone is located under the  button. Be careful not to cover it when you press .

Talking Range



Optimal Range
Flat, open areas

















Medium Range
Buildings or trees











Minimal Range
Dense foliage or
mountains
Buildings or vehicles

Special Features

The following table lists features you can set by pressing and holding specific key combinations while turning on your radio.

Press and Hold While Turning On Your Radio	To
 +  +  or  +  + 	Reset factory settings.
 + 	Turns audible button beeps and local audible call tones on or off.
 + 	Turns Talk Confirmation Tone on or off.
 + 	Turns on Simple Menu mode. See page 44.
 +  (Call)	Turns on or off the Quiet6000 (Setting 1) feature. See page 37.
 + VOX accessory attached	Enables External VOX (with accessory).





Almost all other settings for your radio are done using the same basic key sequence. Use your radio's  and  or  to select and set features the way you want them. All the features that work using this key sequence are described on the following pages.

Press	Display	Then Press
	the icon representing the feature you want	 or  to select the feature, then press  or wait ten seconds (60 seconds for Simple Menu mode) to save the setting or press and hold  .

Interference Eliminator Code

The interference eliminator codes help minimize interference and unwanted messages by providing you with a choice of code combinations. Refer to the Frequency and Code Charts beginning on page 46 for channel and code choices.









1. Press  twice until the code number display begins to blink.
2. Press  or  to set the code, press  to save the code setting.
3. To hear everyone on your channel, select code .

Note: Carrier squelch (0) disables interference eliminator codes. This allows you to monitor all activity on the channel you are using.



ACESSÓRIOS: http://www.acent-radios.com.br/motorola/talk_about/acessorios_talk_about.htm



To specify a different code for each channel:

1. Press  and then press  or  to select the channel.
2. Press  again, then press  or  to select a code.
3. Press  to exit the menu and to save the channel and code combination.
4. To set another channel and code combination, repeat these steps.

Monitor/Signal Strength Indicator

The  button allows you to listen to all activity on a channel (open squelch) to tell whether the channel is currently in use. This button also helps you determine when a radio is moving out of range.

To check for channel activity, press and hold . You'll hear static if the channel is clear and  will display. Don't transmit if you hear conversation. To avoid interrupted conversation, wait until the channel is clear or switch to another channel.

The  helps you determine when a radio is moving out of range by displaying a receive signal-strength value next to the  while you press and hold . This value from 1 (weakest) through 5 (strongest) indicates the relative strength of the incoming signal.

Note: Obstacles that block the signal path may affect the strength of the incoming signal.



Signal Strength Indicator

Setting Sensitivity Level

The sensitivity level allows you to compensate for background noise when using an accessory. If you are not using an accessory, the sensitivity level adjusts your microphone's sensitivity. By adjusting the sensitivity level up or down, you can minimize the chance of unintended noises triggering a transmission, or increase the microphone's ability to pick up quiet voices

To set the sensitivity level, press **MENU** until  and a value from 1 through 3 is displayed, then select:

- **High** (3) for quiet environments
- **Medium** (2) for most environments
- **Low** (1) for noisy environments



When you connect a VOX accessory, the radio is automatically set to your last sensitivity level.

When using an iVOX accessory, there are 5 sensitivity levels to choose from, 1 (lowest) to 5 (highest).

Alerts







Alerts allow members of your group to notify each other that they want to talk. Alerts can be audible, visual, or vibrating.

You can also determine how your radio alerts you when you're receiving: vibrate, ring, both, or none. Your radio vibrates and/or ring only the first time you receive a transmission or call. It does not ring or vibrate again until 30 seconds of inactivity have elapsed.

Call Tone and Call Display

Your radio can transmit different call tones to other radios in your group so you can alert them that you want to talk to them. Each person in the group can have an individual call tone.

To set your call tone:

1. Press  until  is displayed.
2. Press  or  to scroll through the available call tones. The radio plays a sample of each tone as you scroll through them.
3. To use your call tone, press  to transmit it to others. The  icon is displayed next to the channel number.



Ring Only

The ring feature rings the call tone you've selected to notify you of two-way radio reception. When you set this feature, the radio produces the call tone, after 30 seconds of inactivity, each time you receive a two-way radio transmission.







To set the Ring feature, press **MENU** until 🔔 is displayed and then press **⊖** or **⊕** to select **7** or **7**.

If you select **7**, 🔔 remains on the display after you exit the menu.



Ring and/or VibraCall® Alert

Your radio features Ring and/or VibraCall® alert, a vibrating alert to notify you of two-way radio reception in noisy environments.



To set Ring and/or VibraCall® alert, press **MENU** until 🔔 and/or 📳 is displayed then press **⊖** or **⊕** to select the desired setting.

Setting	Display Within Menu	Function
-		Your radio doesn't sound an alert, just the actual transmission. You still hear the talk confirmation tone (if activated).
1		Your radio vibrates to alert you.
2		Your radio rings your call tone when you receive a call.
3		Your radio vibrates and rings your call tone when receiving.

Talk Confirmation Tone

Whenever you turn on the talk confirmation tone feature, your two-way radio transmits a unique tone when you finish transmitting. It's like saying "Roger" or "Over" and lets others know you're finished talking. If you don't hear the talk confirmation tone, you can enable it by pressing and holding  as you turn on your radio. Now, whenever you release the , you let your friends know you're finished talking by transmitting a tone. To disable the talk confirmation tone feature, turn your radio off and then back on while pressing and holding .

Button Beeps

Every time you press a button on your radio, it beeps unless you turn Button Beeps off. To turn Button Beeps off, turn your radio on while you press and hold . To turn Button Beeps back on, turn the radio off and then back on again while you press and hold .



When Button Beeps are turned off, you won't hear call tones that you send.

Privacy



Eavesdrop Reducer



Your radio has the Eavesdrop Reducer feature, a scramble code that makes your transmissions sound garbled to anyone listening without the same scramble code. It doesn't guarantee secrecy, but it adds an extra layer of privacy. Don't forget -- all the radios have to be set to the same Eavesdrop Reducer code for the transmissions to be clear.

To turn the Eavesdrop Reducer feature on, press  until  is displayed, then select scramble code 1, 2, or 3.



After you exit the menu, the display shows .

To turn the Eavesdrop Reducer feature off, press  until  is displayed, then select -. After you exit the menu,  disappears from the display.

Quiet6000™

The Quiet6000™ function helps ensure uninterrupted communication among Motorola Talkabout T6000 series radios - it helps prevent you from hearing transmissions from other radios. However, other radios can hear you.

To turn the Quiet6000 function on or off, press  until **Qr** is displayed. Then select one of the following settings:

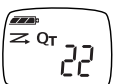



Setting	Display	Function
-		Quiet6000 is turned off.
1		Quiet6000 is turned on, but is suspended while scanning.
2		Quiet6000 is turned on, including while scanning.

You can also turn the Quiet6000 function on (Setting 1) or off (Setting -) by pressing and holding  while you turn on your radio.

ACESSÓRIOS: http://www.acent-radios.com.br/motorola/talk_about/acessorios_talk_about.htm

If your radio has Quiet6000 on and want to talk to others in your group who also have Quiet6000 on, you must first transmit a call tone before talking to them. When the call tone is transmitted,  is displayed on the other radios with the same channel, interference eliminator code, scramble code, and Quiet6000 on, letting them know that you want to talk to them. Those radios can then receive and transmit until 30 seconds of inactivity occurs, which resets the Quiet6000 function. While Quiet6000 is on, **Qr** is displayed. However, during the 30 seconds of inactivity, **Qr** flashes.

Unique Situations

Quiet6000 can also keep your radio quiet when you are in a situation where noise can be disruptive, such as when you are in a movie theater or out hunting. Set Quiet6000 to either  or  and set your radio's alert to  (VibraCall® alert only). Now when you receive a call from radio, your radio vibrates while the  displays on the screen. The  icon remains on the screen until you press any button. Only then can you receive and transmit to those radios until 30 seconds of inactivity occurs and the Quiet6000 function resets.

Weather

Your radio can tune into broadcasts by the United States National Oceanic and Atmospheric Administration (NOAA) Weather Radio and Environment Canada Weatheradio.

You can listen to a weather channel or set your radio to alert you to emergency weather broadcasts that interrupt routine broadcasts.





Both NOAA and Environment Canada have transmitters located throughout the United States and Canada, respectively. These transmitters broadcast watches, forecasts, and other information 24 hours a day.

Note: Service may not be available in all areas. Check with your local weather office for frequency and details, or visit www.nws.noaa.gov/nwr in the US or www.msc-smc.ec.gc.ca/cd/factsheets/wxradio in Canada. The use of the NOAA logo does not provide an endorsement or implied endorsement by NOAA's National Weather Service nor does the use of the Weatheradio logo provide an endorsement or implied endorsement by Environment Canada.

Whenever you listen to a weather channel, you cannot use your radio for two-way communications. However, a weather alert will notify you while the radio is in two-way mode (if you have enabled weather alert) and the radio is on but not transmitting or receiving.



ACESSÓRIOS: http://www.acent-radios.com.br/motorola/talk_about/acessorios_talk_about.htm

Turning On Weather Channel Reception

To turn on weather channel reception, press and hold   . To turn it off and return to two-way mode, press and hold   again.

Setting the Weather Channel

Your radio receives seven frequencies. See the Frequency and Code Charts beginning on page 46 for a complete list.





After turning on the weather broadcast, press  to start the channel display blinking. Press  or  to select the strongest channel.



As with two-way radio reception, weather channel reception depends on how close you are to a transmitter and whether you are indoors or outdoors. Also, because weather channels are transmitted without codes, they may contain static or noise.

Setting the Weather Alert

If you set the weather alert and switch back to two-way mode, ☁ is displayed. Whenever NOAA or Environment Canada transmit an emergency weather broadcast on the selected channel, your radio alerts you using the selected alert mode, ring 🔔 or vibrate 📳, and switches to the selected weather channel. If your radio is in weather mode, you will receive a weather alert only on the selected channel.

To set weather alerts, switch to weather mode, press  twice, and press  or  to select  (on).



Note: The Talkabout T6250 two-way radio is designed to be primarily a two-way radios with added features such as Weather Alert. The radio uses the same circuitry for both two-way radio and weather alert receptions. Therefore, you can miss a weather alert while you are in two-way communication (either transmitting or receiving). To ensure that you do not miss a weather alert, leave the radio in the Weather Mode.

Other Important Features

Lock

To avoid accidentally changing radio operation, the Lock feature locks the Menu, Volume Control, Weather, and Scan functions, meaning that you can only turn the two-way radio on and off, transmit, and monitor.

You can make sure your menu settings won't be changed accidentally. Just turn on lock by pressing  for three seconds.

Now you'll see the  icon.

To turn Lock off, press  again for three seconds.



Note: If your radio is in two-way mode and Weather Alert is enabled, an emergency broadcast on the selected channel will switch the radio to that weather channel.

Lock On







Scanning

By using Scanning , you can monitor channels and codes for transmissions and lock in on the one that interests you. More importantly, you can find someone in your group who has accidentally changed channels and is talking during your scan. You don't have to set a new channel or code, the radio just resets itself temporarily to that channel and code and you can start talking.







To start scanning, briefly press  (Scan/Monitor). Your channel/code screen displays  and begins to scroll through channels. When the radio detects channel activity, it stops on that channel and displays its channel and code. You

ACESSÓRIOS: http://www.acent-radios.com.br/motorola/talk_about/acessorios_talk_about.htm

can talk to the person(s) transmitting without having to switch channels by pressing . To stop scanning, briefly press . If you press  while the radio is scanning, the radio will transmit on the channel you selected before you activated Scan. If no transmission occurs within five seconds, scanning will resume.







If you want to scan channels without interference eliminator codes, change the code for your set channel to  before you briefly press .

Scan List Editing

You can select the channels you want to scan by putting those channels in a scan list. To edit the scan list, press  until  is displayed. Press  or  to scroll through the list of available channels. When you see a channel you want to add to the list, press  until  is displayed to add it or until  is displayed to to remove it.

Auto Power Off





You can program your radio to turn itself off after a certain period of inactivity. This helps save battery life.

To set the automatic power off feature, press  until  is displayed. Press  or  to set the number of hours  - , after which power shuts off.





ACESSÓRIOS: http://www.acent-radios.com.br/motorola/talk_about/acessorios_talk_about.htm
After you exit the menu, **APO** displays on the screen when the automatic power off feature has been activated. Five minutes before the radio shuts off, an alert beep sounds. Another alert beep will sound once per minute and **APO** will flash continuously during those five minutes. Select **-** to turn off the automatic power off feature.





Reset

You can reset your radio's menu settings to the factory settings by turning it on while pressing and holding  and  or  and .



Simple Menu

Simple Menu allows you to limit the number of menus displayed (Channel, Code, and Call Tones) to allow for simpler radio operation. The Scan and Weather features, along with most of the radio turn-on sequences (see page 23), are also disabled to prevent accidentally changing the radio's mode of operation.

If you want the radios in your group to keep the same settings that you have on your radio, press  as you turn each radio on. Simple Menu increases the menu time-out to 60 seconds. To turn off Simple Menu, press  as you turn on the radio.

If you want to set up Simple Menu for inexperienced users, without advanced features activated such as Eavesdrop Reducer and Quiet6000, reset their radios to the original factory settings by pressing  and  or by pressing  and  while turning on their radios. Then activate Simple Menu by turning their radios off and then back on while pressing .



Accessories

Make sure the radio is turned off before plugging audio accessories into the accessory port. Before you place an accessory on your head or in your ear, turn the volume down. After placing the accessory on your head or in your ear, adjust the volume by pressing  or .







Hands-Free Use (VOX) With Accessories

VOX allows you to transmit “hands-free” by talking while using VOX accessories connected to the radio.

To set VOX, plug in your accessory before you turn on your radio. When you turn on your radio, flashing  is displayed. Your radio now detects your voice and transmit every time you talk. When you transmit using a VOX headset, you will hear yourself talking through the accessory speaker. This lets you know VOX is working.

Press  to turn off VOX and return to the regular way of transmitting. The  icon disappears. To reset VOX use, turn your radio off and then back on with your accessory plugged in.

Hands-Free Use Without Accessories (iVOX)

You can use the radio’s VOX feature to transmit handsfree without a connected VOX accessory. Press  until  flashes. Press  or  until  (on) is displayed, then press  twice. Your radio transmits every time you speak.

Note: There is a short delay when you start talking before the transmitter turns on.

Frequency and Code Charts

The charts on these pages provide frequency and code compatibility information. These charts are useful when using Motorola Talkabout two-way radios with other FRS radios.

T6250 Frequency Chart

Channel Display	Talkabout Distance Channel	Channel Type	Frequency (MHz)	Power (Watts)
1	1	GMRS/FRS	462.5625	1
2	2	GMRS/FRS	462.5875	1
3	3	GMRS/FRS	462.6125	1
4	4	GMRS/FRS	462.6375	1
5	5	GMRS/FRS	462.6625	1
6	6	GMRS/FRS	462.6875	1
7	7	GMRS/FRS	462.7125	1
8		FRS	467.5625	0.5
9		FRS	467.5875	0.5
10		FRS	467.6125	0.5
11		FRS	467.6375	0.5

T6250 Frequency Chart

Channel Display	Talkabout Distance Channel	Channel Type	Frequency (MHz)	Power (Watts)
12		FRS	467.6625	0.5
13		FRS	467.6875	0.5
14		FRS	467.7125	0.5
15		GMRS	462.5500	1
16	A	GMRS	462.5750	1
17		GMRS	462.6000	1
18	B	GMRS	462.6250	1
19		GMRS	462.6500	1
20	C	GMRS	462.6750	1
21		GMRS	462.7000	1
22		GMRS	462.7250	1

Interference Eliminator Codes

Code	Freq (Hz)	Motorola 7/7x Code	Code	Freq (Hz)	Motorola 7/7x Code	Code	Freq (Hz)	Motorola 7/7x Code
1	67.0		14	107.2	D	27	167.9	
2	71.9		15	110.9		28	173.8	
3	74.4		16	114.8		29	179.9	
4	77.0	A	17	118.8	E	30	186.2	
5	79.7		18	123.0		31	192.8	
6	82.5		19	127.3	F	32	203.5	
7	85.4		20	131.8		33	210.7	
8	88.5	B	21	136.5	G	34	218.1	
9	91.5		22	141.3		35	225.7	
10	94.8		23	146.2		36	233.6	
11	97.4	C	24	151.4		37	241.8	
12	100.0		25	156.7		38	250.3	
13	103.5		26	162.2				

Note: Motorola 7/7x is an older Motorola radio that has seven codes common with newer FRS radios.

Weather Frequency Chart			
WX1	162.550	WX5	162.450
WX2	162.400	WX6	162.500
WX3	162.475	WX7	162.525
WX4	162.425		

Use and Care



Use a soft damp cloth to clean the exterior.



Do not immerse in water.



Do not use alcohol or cleaning solutions.

If the radio gets wet...



Turn it off and remove batteries.





Dry with soft cloth.





Do not use until completely dry.

Troubleshooting

Symptom	Try This:
No Power	Reposition or replace alkaline batteries. Recharge or replace NiMH battery.
Message not transmitted	Make sure  is completely pressed as you transmit. Reposition, replace, or recharge batteries.
Hearing other noises or conversation on a channel	Confirm interference eliminator code is set. Shared channel or interference eliminator code may be in use, try another.
Message scrambled	Eavesdrop Reducer code is on, or setting does not match other radios' settings; all radios must use the same Eavesdrop Reducer code.
Limited talk range	Steel and/or concrete structures, heavy foliage, use in buildings or vehicles decrease range. Check for clear line of sight to improve transmission. Wearing radio close to body such as in a pocket or on a belt decreases range. Change location of radio.

Symptom	Try This:
<p>Message not received</p>	<p>Confirm radios have the same channel and interference eliminator code settings.</p> <p>Make sure  is NOT being pressed while trying to listen.</p> <p>Reposition, replace, or recharge batteries.</p> <p>If QuietT6000 feature is on, transmit call tone before talking.</p> <p>If QuietT6000 feature is on, with only VibraCall® alert selected, a received call must be acknowledged by pressing any button (or a VOX activation) before the radio can receive any incoming transmissions.</p> <p>Obstructions and operating indoors, or in vehicles, may interfere -- change location.</p> <p>Verify that the radio is not in Scan mode.</p> <p>Eavesdrop Reducer code is on, or setting does not match other radios; all radios must use the same Eavesdrop Reducer code.</p>

Symptom	Try This:
Heavy static or interference	Radios are too close, they must be at least five feet apart. Radios are too far apart or obstacles interfering with transmission. Talk range is up to two miles depending on terrain and conditions.
Channel and/or code locked	Make sure menu is unlocked. Unlock by pressing  for three seconds.
Cannot access all menus or Cannot display desired icon	Verify whether Simple Menu is activated. Disable Simple Menu by pressing  while turning on the radio.
Other radios not receiving your transmissions	Quiet6000 mode is set. Press  to talk to members of your party or turn Quiet6000 off.
Low batteries	Replace alkaline batteries. Recharge or replace NiMH battery. Extreme operating temperatures affect battery life.

Symptom	Try This:
Low battery meter reading although new batteries are installed	Verify that the radio is set to the correct battery type. See page 17.
Charger LED double flashing	Charger not properly positioned. Reposition charger and ensure it is firmly clamped to the radio, battery, or charging dock. Battery power is very low; battery is charging up slowly before it starts to quick charge.
Cannot activate VOX	Feature not set and on.

Motorola Limited Warranty

for the United States and Canada

What Does this Warranty Cover?

Subject to the exclusions contained below, Motorola, Inc. warrants its telephones, pagers, and consumer and professional two-way radios (excluding commercial, government or industrial radios) that operate via Family Radio Service or General Mobile Radio Service, Motorola-branded or certified accessories sold for use with these Products (“Accessories”) and Motorola software contained on CD-ROMs or other tangible media and sold for use with these Products (“Software”) to be free from defects in materials and workmanship under normal consumer usage for the period(s) outlined below. This limited warranty is a consumer’s exclusive remedy, and applies as follows to new Motorola Products, Accessories and Software purchased by consumers in the United States or Canada, which are accompanied by this written warranty:

Products and Accessories

Products Covered	Length of Coverage
Products and Accessories as defined above, unless otherwise provided for below.	One (1) year from the date of purchase by the first consumer purchaser of the product unless otherwise provided for below.

Products Covered	Length of Coverage
<p>Decorative Accessories and Cases. Decorative covers, bezels, PhoneWrap™ covers and cases.</p>	<p>Limited lifetime warranty for the lifetime of ownership by the first consumer purchaser of the product.</p>
<p>Monaural Headsets. Ear buds and boom headsets that transmit mono sound through a wired connection.</p>	<p>Limited lifetime warranty for the lifetime of ownership by the first consumer purchaser of the product.</p>
<p>Consumer and Professional Two-Way Radio Accessories.</p>	<p>Ninety (90) days from the date of purchase by the first consumer purchaser of the product.</p>
<p>Products and Accessories that are Repaired or Replaced.</p>	<p>The balance of the original warranty or for ninety (90) days from the date returned to the consumer, whichever is longer.</p>

Exclusions

Normal Wear and Tear. Periodic maintenance, repair and replacement of parts due to normal wear and tear are excluded from coverage.

Batteries. Only batteries whose fully charged capacity falls below 80% of their rated capacity and batteries that leak are covered by this limited warranty.

Abuse & Misuse. Defects or damage that result from: (a) improper operation, storage, misuse or abuse, accident or neglect, such as physical damage (cracks,

ACESSÓRIOS: http://www.acent-radios.com.br/motorola/talk_about/acessorios_talk_about.htm scratches, etc.) to the surface of the product resulting from misuse; (b) contact with liquid, water, rain, extreme humidity or heavy perspiration, sand, dirt or the like, extreme heat, or food; (c) use of the Products or Accessories for commercial purposes or subjecting the Product or Accessory to abnormal usage or conditions; or (d) other acts which are not the fault of Motorola, are excluded from coverage.

Use of Non-Motorola Products and Accessories. Defects or damage that result from the use of Non-Motorola branded or certified Products, Accessories, Software or other peripheral equipment are excluded from coverage.

Unauthorized Service or Modification. Defects or damages resulting from service, testing, adjustment, installation, maintenance, alteration, or modification in any way by someone other than Motorola, or its authorized service centers, are excluded from coverage.

Altered Products. Products or Accessories with (a) serial numbers or date tags that have been removed, altered or obliterated; (b) broken seals or that show evidence of tampering; (c) mismatched board serial numbers; or (d) nonconforming or non-Motorola housings, or parts, are excluded from coverage.

Communication Services. Defects, damages, or the failure of Products, Accessories or Software due to any communication service or signal you may subscribe to or use with the Products Accessories or Software is excluded from coverage.

Software

Products Covered	Length of Coverage
Software. Applies only to physical defects in the media that embodies the copy of the software (e.g. CD-ROM, or floppy disk).	Ninety (90) days from the date of purchase.

Exclusions

Software Embodied in Physical Media. No warranty is made that the software will meet your requirements or will work in combination with any hardware or software applications provided by third parties, that the operation of the software products will be uninterrupted or error free, or that all defects in the software products will be corrected.

Software NOT Embodied in Physical Media. Software that is not embodied in physical media (e.g. software that is downloaded from the internet), is provided “as is” and without warranty.

Who is Covered?

This warranty extends only to the first consumer purchaser, and is not transferable.

What Will Motorola Do?

Motorola, at its option, will at no charge repair, replace or refund the purchase price of any Products, Accessories or Software that does not conform to this warranty. We may use functionally equivalent reconditioned/refurbished/pre-owned or new Products, Accessories or parts. No data, software or applications added to your Product, Accessory or Software, including but not limited to personal contacts, games and ringer tones, will be reinstalled. To avoid losing such data, software and applications please create a back up prior to requesting service.

How to Obtain Warranty Service or Other Information?

USA	Phones 1-800-331-6456 Two-Way Radios 1-800-353-2729 Pagers 1-800-548-9954
Canada	All Products 1-800-461-4575
TTY	TTY 1-888-390-6456
For Accessories and Software , please call the telephone number designated above for the product with which they are used.	

You will receive instructions on how to ship the Products, Accessories or Software, at your expense, to a Motorola Authorized Repair Center. To obtain service, you must include: (a) a copy of your receipt, bill of sale or other comparable proof of purchase; (b) a written description of the problem; (c) the

ACESSÓRIOS: http://www.acent-radios.com.br/motorola/talk_about/acessorios_talk_about.htm
name of your service provider, if applicable; (d) the name and location of the installation facility (if applicable) and, most importantly; (e) your address and telephone number.

What Other Limitations Are There?

ANY IMPLIED WARRANTIES, INCLUDING WITHOUT LIMITATION THE IMPLIED WARRANTIES OF MERCHANTABILITY AND FITNESS FOR A PARTICULAR PURPOSE, SHALL BE LIMITED TO THE DURATION OF THIS LIMITED WARRANTY, OTHERWISE THE REPAIR, REPLACEMENT, OR REFUND AS PROVIDED UNDER THIS EXPRESS LIMITED WARRANTY IS THE EXCLUSIVE REMEDY OF THE CONSUMER, AND IS PROVIDED IN LIEU OF ALL OTHER WARRANTIES, EXPRESS OR IMPLIED. IN NO EVENT SHALL MOTOROLA BE LIABLE, WHETHER IN CONTRACT OR TORT (INCLUDING NEGLIGENCE) FOR DAMAGES IN EXCESS OF THE PURCHASE PRICE OF THE PRODUCT, ACCESSORY OR SOFTWARE, OR FOR ANY INDIRECT, INCIDENTAL, SPECIAL OR CONSEQUENTIAL DAMAGES OF ANY KIND, OR LOSS OF REVENUE OR PROFITS, LOSS OF BUSINESS, LOSS OF INFORMATION OR DATA, SOFTWARE OR APPLICATIONS OR OTHER FINANCIAL LOSS ARISING OUT OF OR IN CONNECTION WITH THE ABILITY OR INABILITY TO USE THE PRODUCTS, ACCESSORIES OR SOFTWARE TO THE FULL EXTENT THESE DAMAGES MAY BE DISCLAIMED BY LAW.

Some states and jurisdictions do not allow the limitation or exclusion of incidental or consequential damages, or limitation on the length of an implied warranty, so the above limitations or exclusions may not apply to

ACESSÓRIOS: http://www.acent-radios.com.br/motorola/talk_about/acessorios_talk_about.htm

you. This warranty gives you specific legal rights, and you may also have other rights that vary from state to state or from one jurisdiction to another.

Laws in the United States and other countries preserve for Motorola certain exclusive rights for copyrighted Motorola software such as the exclusive rights to reproduce and distribute copies of the Motorola software. Motorola software may only be copied into, used in, and redistributed with, the Products associated with such Motorola software. No other use, including without limitation disassembly of such Motorola software or exercise of the exclusive rights reserved for Motorola, is permitted.

Software Copyright Notice

The Motorola products described in this manual may include copyrighted Motorola and third party software stored in semiconductor memories or other media. Laws in the United States and other countries preserve for Motorola and third party software providers certain exclusive rights for copyrighted software, such as the exclusive rights to distribute or reproduce the copyrighted software. Accordingly, any copyrighted software contained in the Motorola products may not be modified, reverse-engineered, distributed, or reproduced in any manner to the extent allowed by law. Furthermore, the purchase of the Motorola products shall not be deemed to grant either directly or by implication, estoppel, or otherwise, any license under the copyrights, patents, or patent applications of Motorola or any third party software provider, except for the normal, non-exclusive, royalty-free license to use that arises by operation of law in the sale of a product.

Patent Notice

This product is covered by one or more of the following United States patents.

5896277 5894292 5864752 5699006 5742484 D408396 D399821 D387758
D389158 5894592 5893027 5789098 5734975 5861850 D395882 D383745
D389827 D389139 5929825 5926514 5953640 6071640 D413022 D416252
D416893 D433001

Export Law Assurances

This product is controlled under the export regulations of the United States of America and Canada. The Governments of the United States of America and Canada may restrict the exportation or re-exportation of this product to certain destinations. For further information contact the U.S. Department of Commerce or the Canadian Department of Foreign Affairs and International Trade.

ACESSÓRIOS: http://www.acent-radios.com.br/motorola/talk_about/acessorios_talk_about.htm

• **No license fee or airtime charges!**

• **Up to 5 mile range**

*Depending on terrain and conditions

• **22 channels, each with 38 interference eliminator codes**

Privacy feature that helps minimize interference from other groups

• **Multiple Audible Call Tones**

Multiple distinct ringing options so your group can identify who's calling

• **Scan**

Easily finds your group's channel and code by searching all combinations

• **Automatic Power Off**

Saves battery life by shutting down after user-defined period of inactivity

• **Weather-resistant**

• **Illuminated Display**

Easy to read your settings in dark places

• **Keypad Lock**

Prevents your settings from being accidentally changed

• **Rechargeable Battery Kit**

Keep a spare battery charged and ready to go with this optional accessory

• **Vehicle Power Adapter**

Recharge your radio on the go with this optional accessory (works with NiMH rechargeable battery, not included)

• **Quiet6000™**

Helps keep radios outside your group from disturbing you with ring tones or conversation

• **Quick release Swivel Belt Clip included**

• **User's guide included**

• **Batteries (not included)**

Requires 3 AA Alkaline batteries or one NiMH rechargeable battery

• **Low Battery Alert**

Audible tone and visual display tell you when battery is running down

• **Talk Hands-Free (VOX / iVOX)**

"Voice activation" (VOX / iVOX) lets you talk hands-free with or without optional accessories

• **1 Year Limited Warranty**

To obtain a copy of this warranty prior to purchase, please ask retailer

FCC GMRS LICENSE REQUIRED

• **Accessories for T6200 series - Convenient headphones, some with hands-free talk capabilities, mesh and waterproof carry cases, and rechargeable battery packs available from your retailer or www.motorola.com**

Note: Weather radio service may not be available in all areas. Check with your local weather office for frequency and details or visit www.nws.noaa.gov/nwr in the US or www.msc-smc.ec.gc.ca/cd/factsheets/wxradio in Canada. The use of the NOAA logo does not provide an endorsement or implied endorsement by NOAA's National Weather Service nor does the use of the Weatheradio logo provide an endorsement or implied endorsement by Environment Canada.

MOTOROLA, the Stylized M Logo, TALKABOUT, and all other trademarks indicated as such herein are trademarks of Motorola, Inc. ® Reg. U.S. Pat. & Tm. Off. All other product or service names are the property of their respective owners. © 2002 Motorola, Inc. All rights reserved.

 **WARNING**
CHOKING HAZARD - SMALL PARTS
Not for children under 3 years.
This product is not intended to be used as a toy or plaything.